

# IRF7389

## HEXFET® Power MOSFET

- Generation V Technology
- Ultra Low On-Resistance
- Complimentary Half Bridge
- Surface Mount
- Fully Avalanche Rated

### Description

Fifth Generation HEXFETs from International Rectifier utilize advanced processing techniques to achieve extremely low on-resistance per silicon area. This benefit, combined with the fast switching speed and ruggedized device design that HEXFET Power MOSFETs are well known for, provides the designer with an extremely efficient and reliable device for use in a wide variety of applications.

The SO-8 has been modified through a customized leadframe for enhanced thermal characteristics and multiple-die capability making it ideal in a variety of power applications. With these improvements, multiple devices can be used in an application with dramatically reduced board space. The package is designed for vapor phase, infra red, or wave soldering techniques.

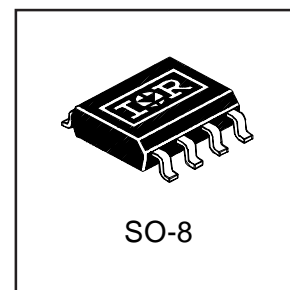
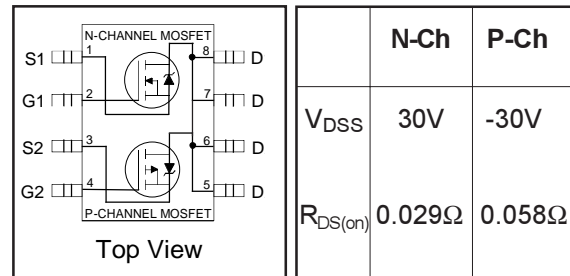

### Absolute Maximum Ratings ( $T_A = 25^\circ\text{C}$ Unless Otherwise Noted)

	Symbol	Maximum		Units
		N-Channel	P-Channel	
Drain-Source Voltage	$V_{DS}$	30	-30	
Gate-Source Voltage	$V_{GS}$	$\pm 20$		
Continuous Drain Current <sup>Ⓒ</sup>	$T_A = 25^\circ\text{C}$ $T_A = 70^\circ\text{C}$	7.3	-5.3	A
		5.9	-4.2	
Pulsed Drain Current	$I_{DM}$	30	-30	
Continuous Source Current (Diode Conduction)	$I_S$	2.5	-2.5	
Maximum Power Dissipation <sup>Ⓒ</sup>	$T_A = 25^\circ\text{C}$ $T_A = 70^\circ\text{C}$	2.5		W
		1.6		
Single Pulse Avalanche Energy	$E_{AS}$	82	140	mJ
Avalanche Current	$I_{AR}$	4.0	-2.8	A
Repetitive Avalanche Energy	$E_{AR}$	0.20		mJ
Peak Diode Recovery $dv/dt$ <sup>Ⓓ</sup>	$dv/dt$	3.8	-2.2	V/ ns
Junction and Storage Temperature Range	$T_J, T_{STG}$	-55 to + 150 °C		

### Thermal Resistance Ratings

Parameter	Symbol	Limit	Units
Maximum Junction-to-Ambient <sup>Ⓒ</sup>	$R_{\theta JA}$	50	$^\circ\text{C/W}$

## Electrical Characteristics @ T<sub>J</sub> = 25°C (unless otherwise specified)

Parameter	Conditions	Min.	Typ.	Max.	Units		
		Parameter					
V <sub>(BR)DSS</sub>	Drain-to-Source Breakdown Voltage	N-Ch	30	—	V	V <sub>GS</sub> = 0V, I <sub>D</sub> = 250μA	
		P-Ch	-30	—		V <sub>GS</sub> = 0V, I <sub>D</sub> = -250μA	
ΔV <sub>(BR)DSS</sub> /ΔT <sub>J</sub>	Breakdown Voltage Temp. Coefficient	N-Ch	—	0.022	V/°C	Reference to 25°C, I <sub>D</sub> = 1mA	
		P-Ch	—	0.022		Reference to 25°C, I <sub>D</sub> = -1mA	
R <sub>DS(ON)</sub>	Static Drain-to-Source On-Resistance	N-Ch	—	0.023	Ω	V <sub>GS</sub> = 10V, I <sub>D</sub> = 5.8A ④	
			—	0.032		0.046	V <sub>GS</sub> = 4.5V, I <sub>D</sub> = 4.7A ④
		P-Ch	—	0.042		0.058	V <sub>GS</sub> = -10V, I <sub>D</sub> = -4.9A ④
			—	0.076		0.098	V <sub>GS</sub> = -4.5V, I <sub>D</sub> = -3.6A ④
V <sub>GS(th)</sub>	Gate Threshold Voltage	N-Ch	1.0	—	V	V <sub>DS</sub> = V <sub>GS</sub> , I <sub>D</sub> = 250μA	
		P-Ch	-1.0	—		V <sub>DS</sub> = V <sub>GS</sub> , I <sub>D</sub> = -250μA	
g <sub>fs</sub>	Forward Transconductance	N-Ch	—	14	S	V <sub>DS</sub> = 15V, I <sub>D</sub> = 5.8A ④	
		P-Ch	—	7.7		V <sub>DS</sub> = -15V, I <sub>D</sub> = -4.9A ④	
I <sub>DSS</sub>	Drain-to-Source Leakage Current	N-Ch	—	1.0	μA	V <sub>DS</sub> = 24V, V <sub>GS</sub> = 0V	
		P-Ch	—	-1.0		V <sub>DS</sub> = -24V, V <sub>GS</sub> = 0V	
		N-Ch	—	25		V <sub>DS</sub> = 24V, V <sub>GS</sub> = 0V, T <sub>J</sub> = 55°C	
		P-Ch	—	-25		V <sub>DS</sub> = -24V, V <sub>GS</sub> = 0V, T <sub>J</sub> = 55°C	
I <sub>GSS</sub>	Gate-to-Source Forward Leakage	N-P	—	±100	nA	V <sub>GS</sub> = ±20V	
Q <sub>g</sub>	Total Gate Charge	N-Ch	—	22	nC	N-Channel I <sub>D</sub> = 5.8A, V <sub>DS</sub> = 15V, V <sub>GS</sub> = 10V ④	
		P-Ch	—	23			34
Q <sub>gs</sub>	Gate-to-Source Charge	N-Ch	—	2.6	nC	P-Channel I <sub>D</sub> = -4.9A, V <sub>DS</sub> = -15V, V <sub>GS</sub> = -10V ④	
		P-Ch	—	3.8			5.7
Q <sub>gd</sub>	Gate-to-Drain ("Miller") Charge	N-Ch	—	6.4	nC	N-Channel V <sub>DD</sub> = 15V, I <sub>D</sub> = 1.0A, R <sub>G</sub> = 6.0Ω, R <sub>D</sub> = 15Ω ④	
		P-Ch	—	5.9			8.9
t <sub>d(on)</sub>	Turn-On Delay Time	N-Ch	—	8.1	ns	P-Channel V <sub>DD</sub> = -15V, I <sub>D</sub> = -1.0A, R <sub>G</sub> = 6.0Ω, R <sub>D</sub> = 15Ω ④	
		P-Ch	—	13			19
t <sub>r</sub>	Rise Time	N-Ch	—	8.9	ns	N-Channel V <sub>GS</sub> = 0V, V <sub>DS</sub> = 25V, f = 1.0MHz	
		P-Ch	—	13			20
t <sub>d(off)</sub>	Turn-Off Delay Time	N-Ch	—	26	ns	P-Channel V <sub>GS</sub> = 0V, V <sub>DS</sub> = -25V, f = 1.0MHz	
		P-Ch	—	34			51
t <sub>f</sub>	Fall Time	N-Ch	—	17	ns	N-Channel V <sub>GS</sub> = 0V, V <sub>DS</sub> = 25V, f = 1.0MHz	
		P-Ch	—	32			48
C <sub>iss</sub>	Input Capacitance	N-Ch	—	650	pF	P-Channel V <sub>GS</sub> = 0V, V <sub>DS</sub> = -25V, f = 1.0MHz	
		P-Ch	—	710			—
C <sub>oss</sub>	Output Capacitance	N-Ch	—	320	pF	N-Channel I <sub>S</sub> = 4.0A, di/dt = 74A/μs, V <sub>DD</sub> ≤ V <sub>(BR)DSS</sub> , T <sub>J</sub> ≤ 150°C	
		P-Ch	—	380			—
C <sub>rss</sub>	Reverse Transfer Capacitance	N-Ch	—	130	pF	P-Channel I <sub>S</sub> = -2.8A, di/dt = 150A/μs, V <sub>DD</sub> ≤ V <sub>(BR)DSS</sub> , T <sub>J</sub> ≤ 150°C	
		P-Ch	—	180			—

## Source-Drain Ratings and Characteristics

Parameter	Conditions	Min.	Typ.	Max.	Units	
		Parameter				
I <sub>S</sub>	Continuous Source Current (Body Diode)	N-Ch	—	2.5	A	
		P-Ch	—	-2.5		
I <sub>SM</sub>	Pulsed Source Current (Body Diode) ①	N-Ch	—	30	A	
		P-Ch	—	-30		
V <sub>SD</sub>	Diode Forward Voltage	N-Ch	—	0.78	V	T <sub>J</sub> = 25°C, I <sub>S</sub> = 1.7A, V <sub>GS</sub> = 0V ③
		P-Ch	—	-0.78		-1.0
t <sub>rr</sub>	Reverse Recovery Time	N-Ch	—	45	ns	N-Channel T <sub>J</sub> = 25°C, I <sub>F</sub> = 1.7A, di/dt = 100A/μs ④
		P-Ch	—	44		
Q <sub>rr</sub>	Reverse Recovery Charge	N-Ch	—	58	nC	P-Channel T <sub>J</sub> = 25°C, I <sub>F</sub> = -1.7A, di/dt = 100A/μs ④
		P-Ch	—	42		

### Notes:

- ① Repetitive rating; pulse width limited by max. junction temperature. ( See fig. 22 )
- ② N-Channel I<sub>SD</sub> ≤ 4.0A, di/dt ≤ 74A/μs, V<sub>DD</sub> ≤ V<sub>(BR)DSS</sub>, T<sub>J</sub> ≤ 150°C
- ③ N-Channel Starting T<sub>J</sub> = 25°C, L = 10mH R<sub>G</sub> = 25Ω, I<sub>AS</sub> = 4.0A. (See Figure 12)
- ④ Pulse width ≤ 300μs; duty cycle ≤ 2%.
- ⑤ Surface mounted on FR-4 board, t ≤ 10sec.
- P-Channel I<sub>SD</sub> ≤ -2.8A, di/dt ≤ 150A/μs, V<sub>DD</sub> ≤ V<sub>(BR)DSS</sub>, T<sub>J</sub> ≤ 150°C
- P-Channel Starting T<sub>J</sub> = 25°C, L = 35mH R<sub>G</sub> = 25Ω, I<sub>AS</sub> = -2.8A.

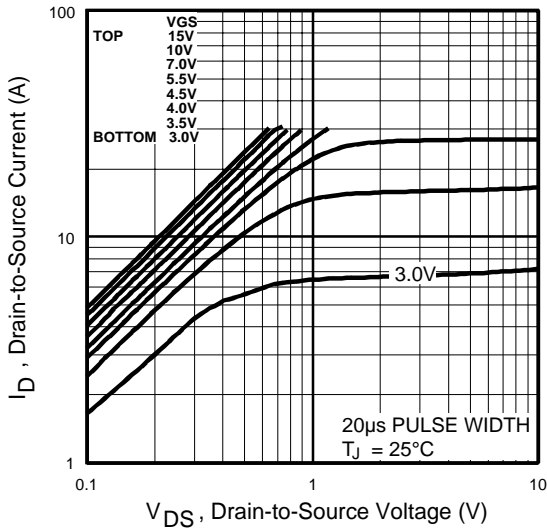

Fig 1. Typical Output Characteristics

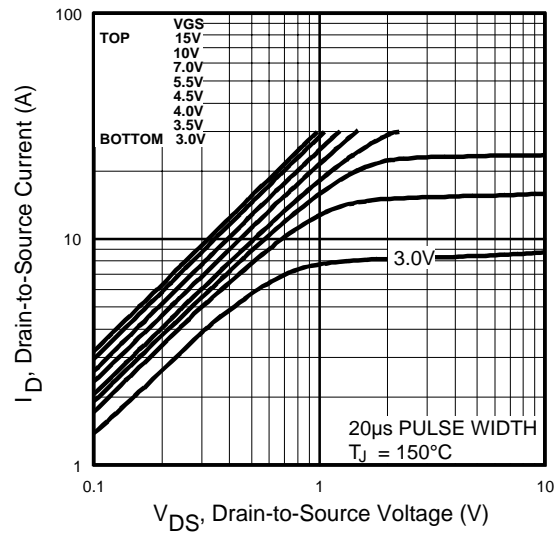

Fig 2. Typical Output Characteristics

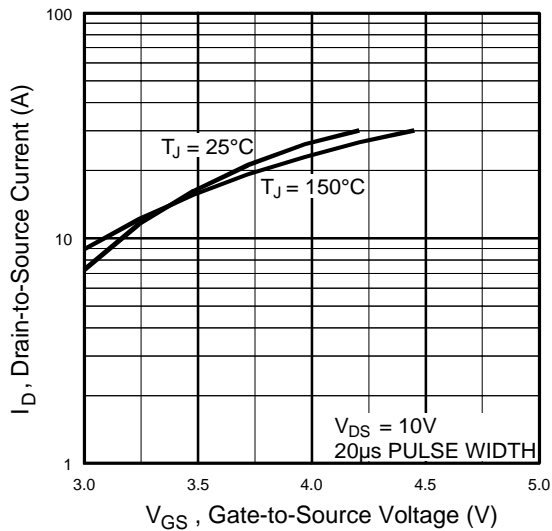

Fig 3. Typical Transfer Characteristics

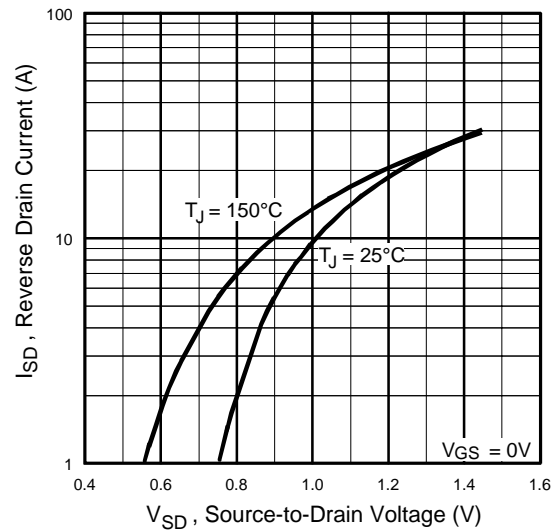
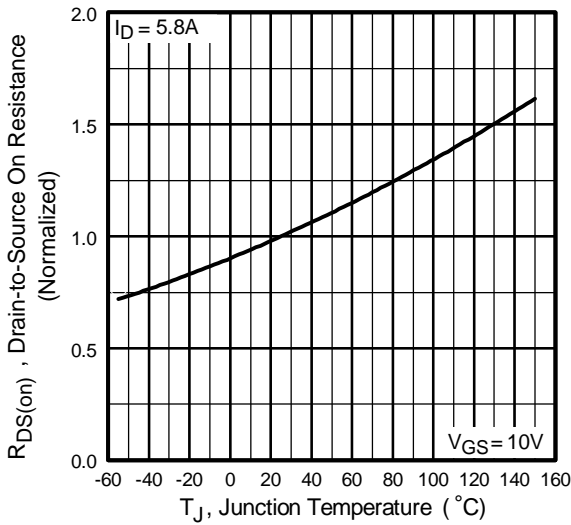
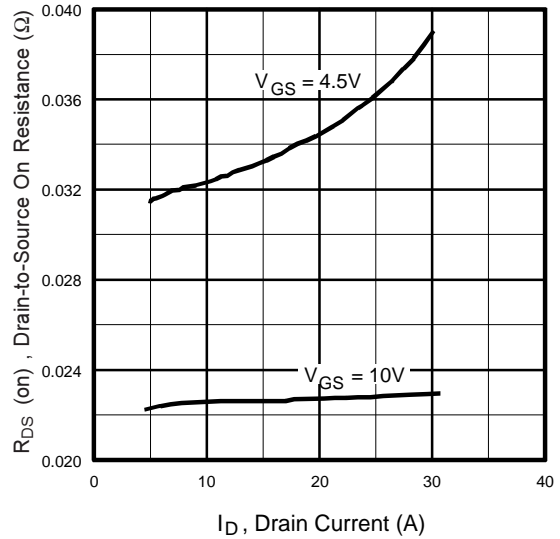

Fig 4. Typical Source-Drain Diode Forward Voltage



**Fig 5.** Normalized On-Resistance Vs. Temperature



**Fig 6.** Typical On-Resistance Vs. Drain Current

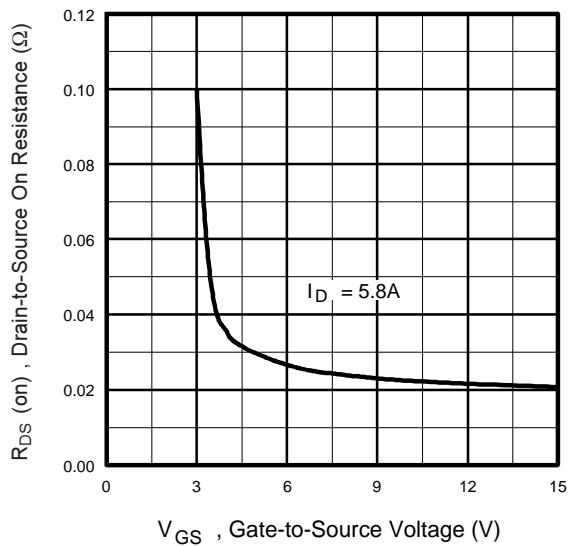

**Fig 7.** Typical On-Resistance Vs. Gate Voltage

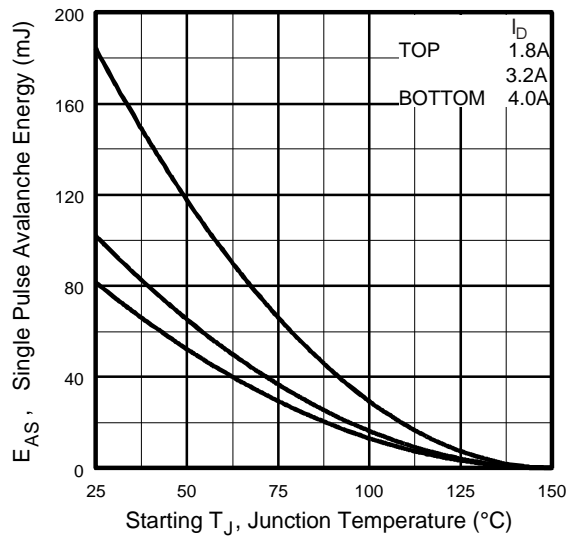

**Fig 8.** Maximum Avalanche Energy Vs. Drain Current

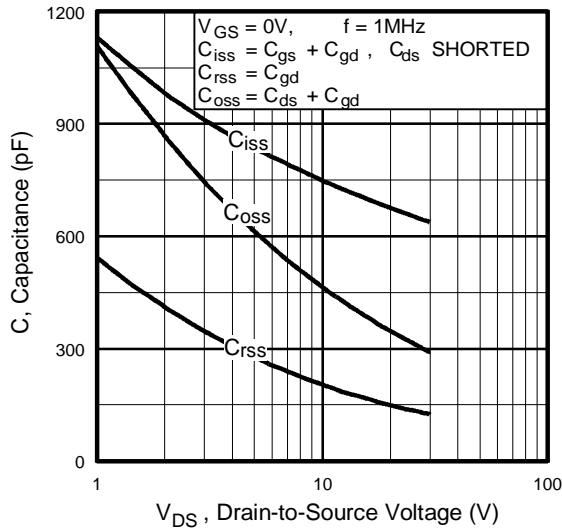

Fig 9. Typical Capacitance Vs. Drain-to-Source Voltage

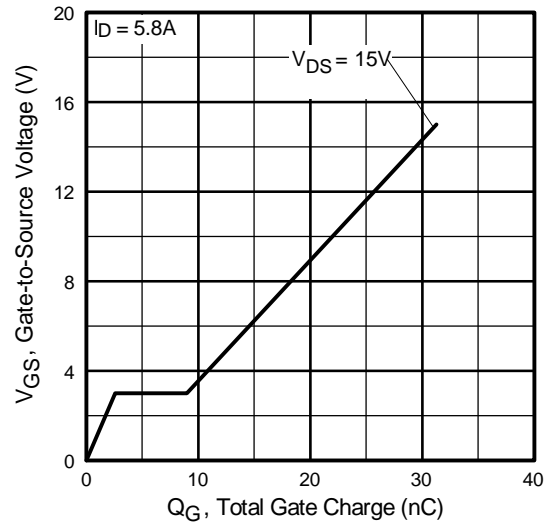

Fig 10. Typical Gate Charge Vs. Gate-to-Source Voltage

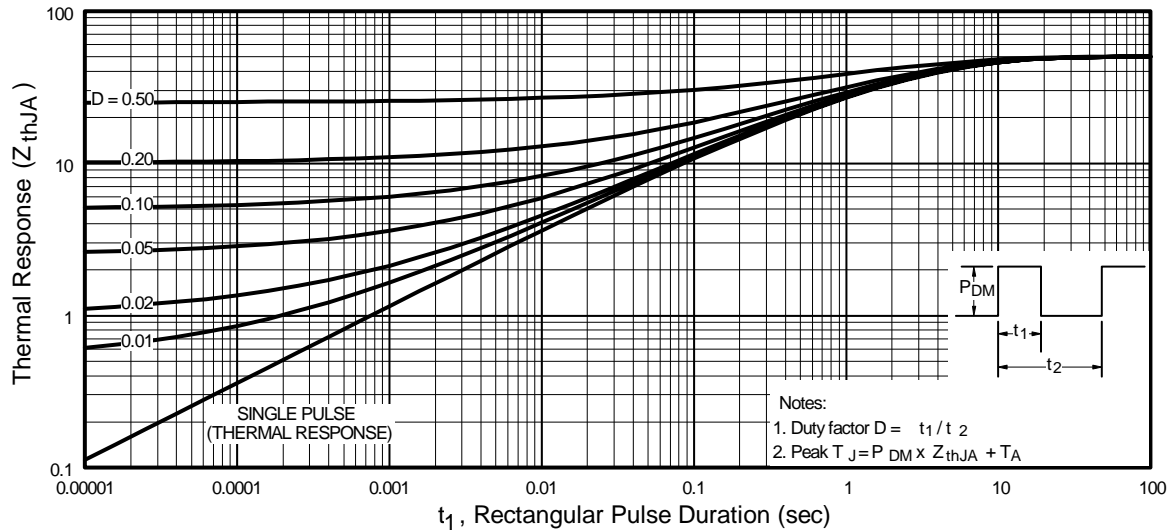
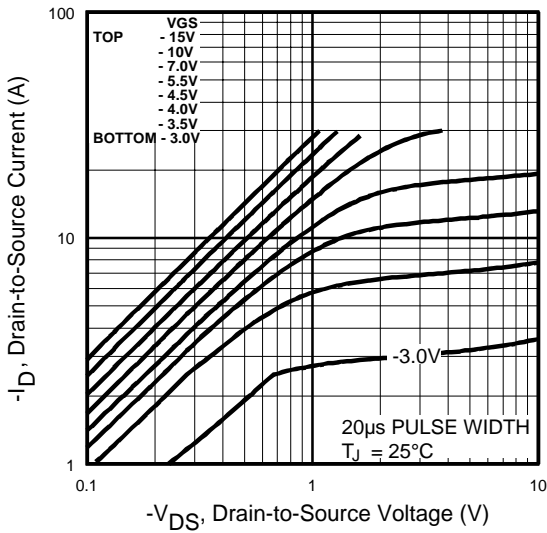
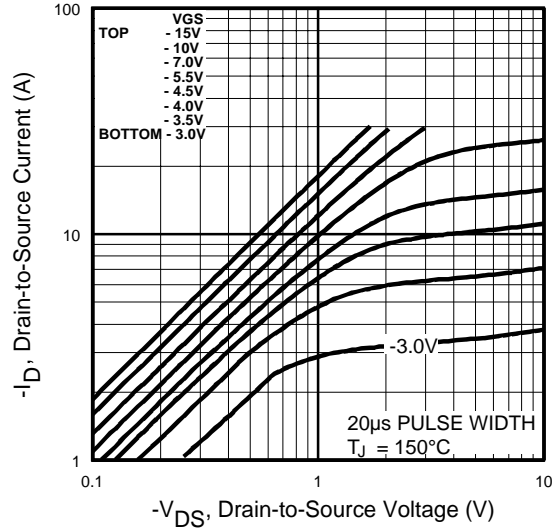

Fig 11. Maximum Effective Transient Thermal Impedance, Junction-to-Ambient



**Fig 12.** Typical Output Characteristics



**Fig 13.** Typical Output Characteristics

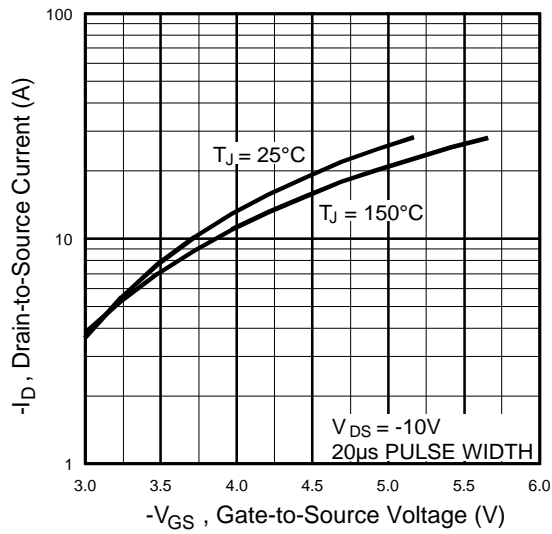

**Fig 14.** Typical Transfer Characteristics

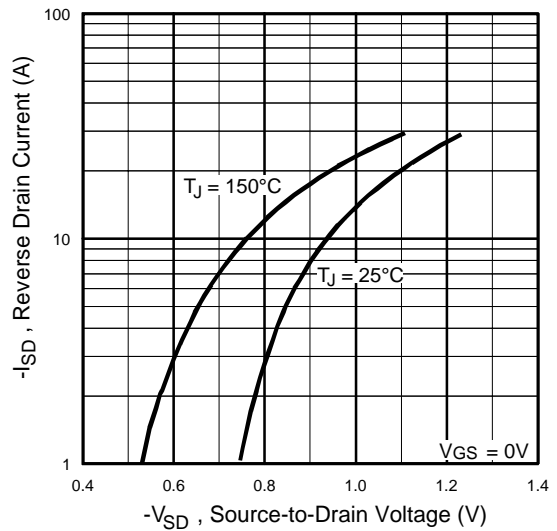

**Fig 15.** Typical Source-Drain Diode Forward Voltage

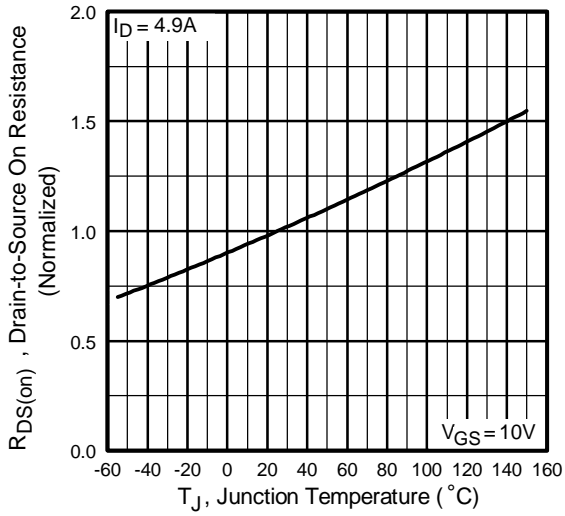

**Fig 16.** Normalized On-Resistance Vs. Temperature

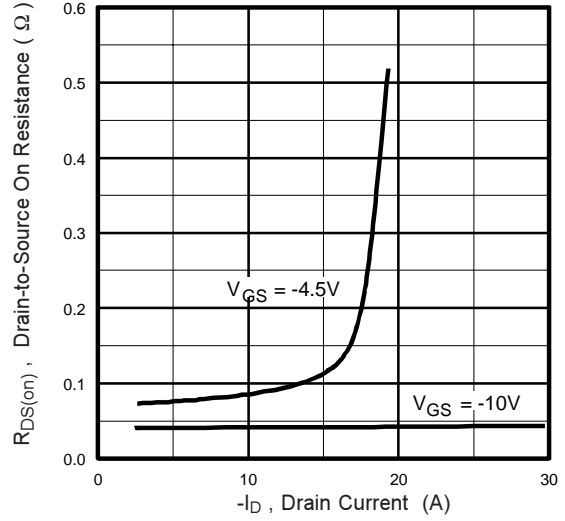

**Fig 17.** Typical On-Resistance Vs. Drain Current

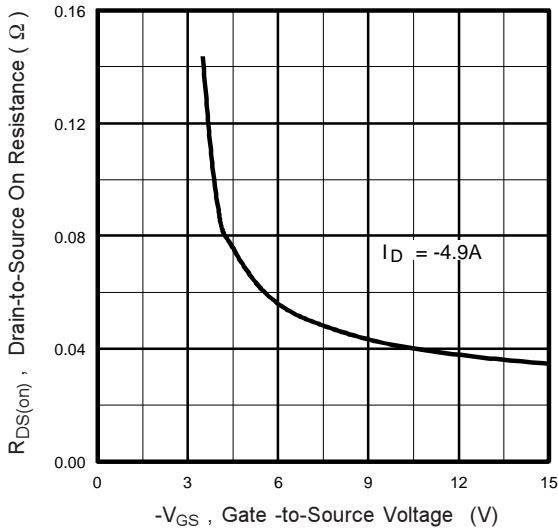

**Fig 18.** Typical On-Resistance Vs. Gate Voltage

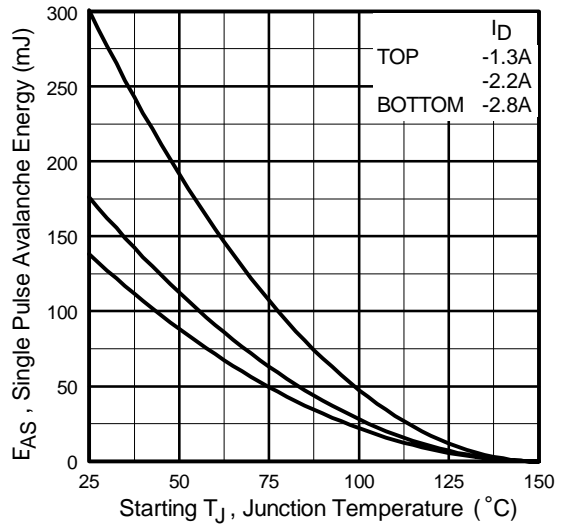

**Fig 19.** Maximum Avalanche Energy Vs. Drain Current

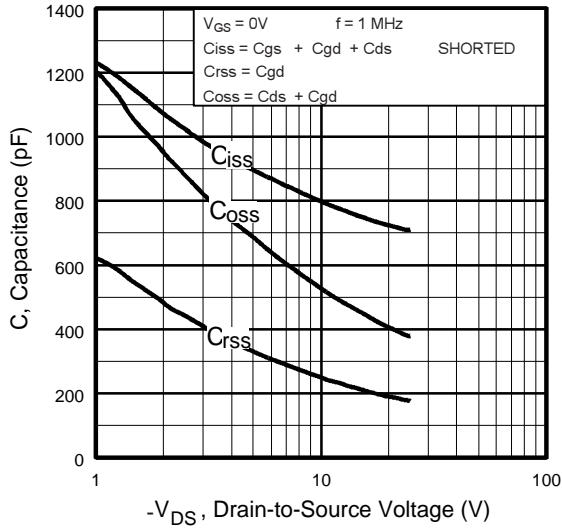

**Fig 20.** Typical Capacitance Vs. Drain-to-Source Voltage

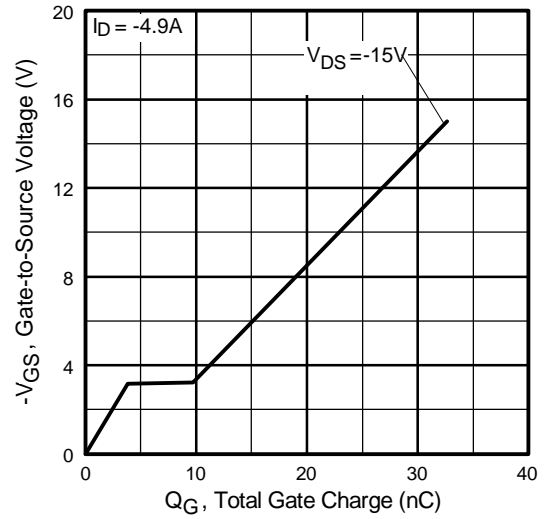

**Fig 21.** Typical Gate Charge Vs. Gate-to-Source Voltage

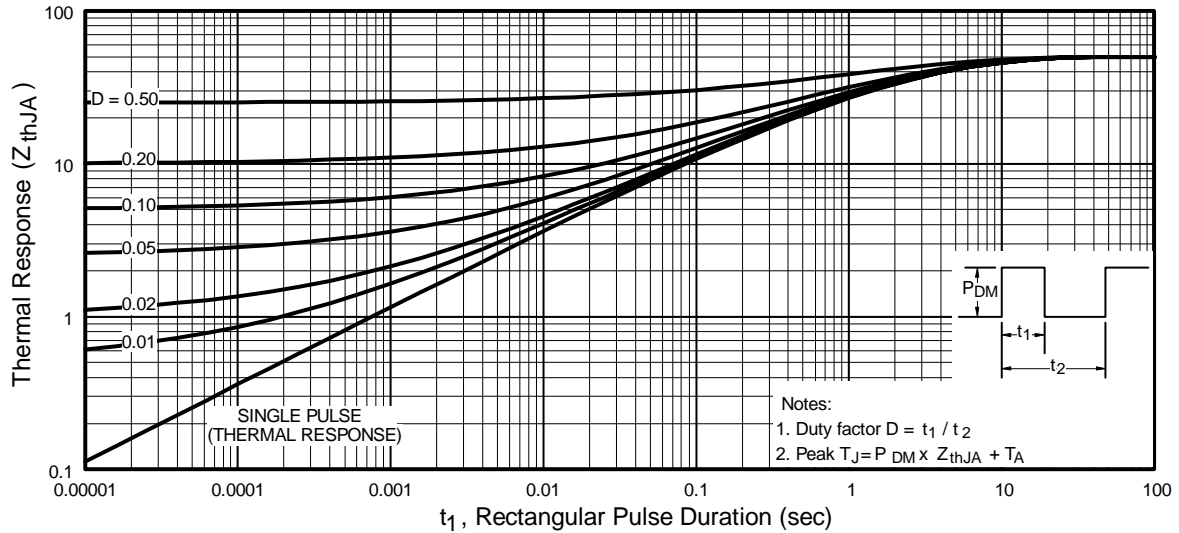

**Fig 22.** Maximum Effective Transient Thermal Impedance, Junction-to-Ambient





# IRF7389

International  
**IR** Rectifier

## Tape & Reel Information

S08

Dimensions are shown in millimeters (inches)

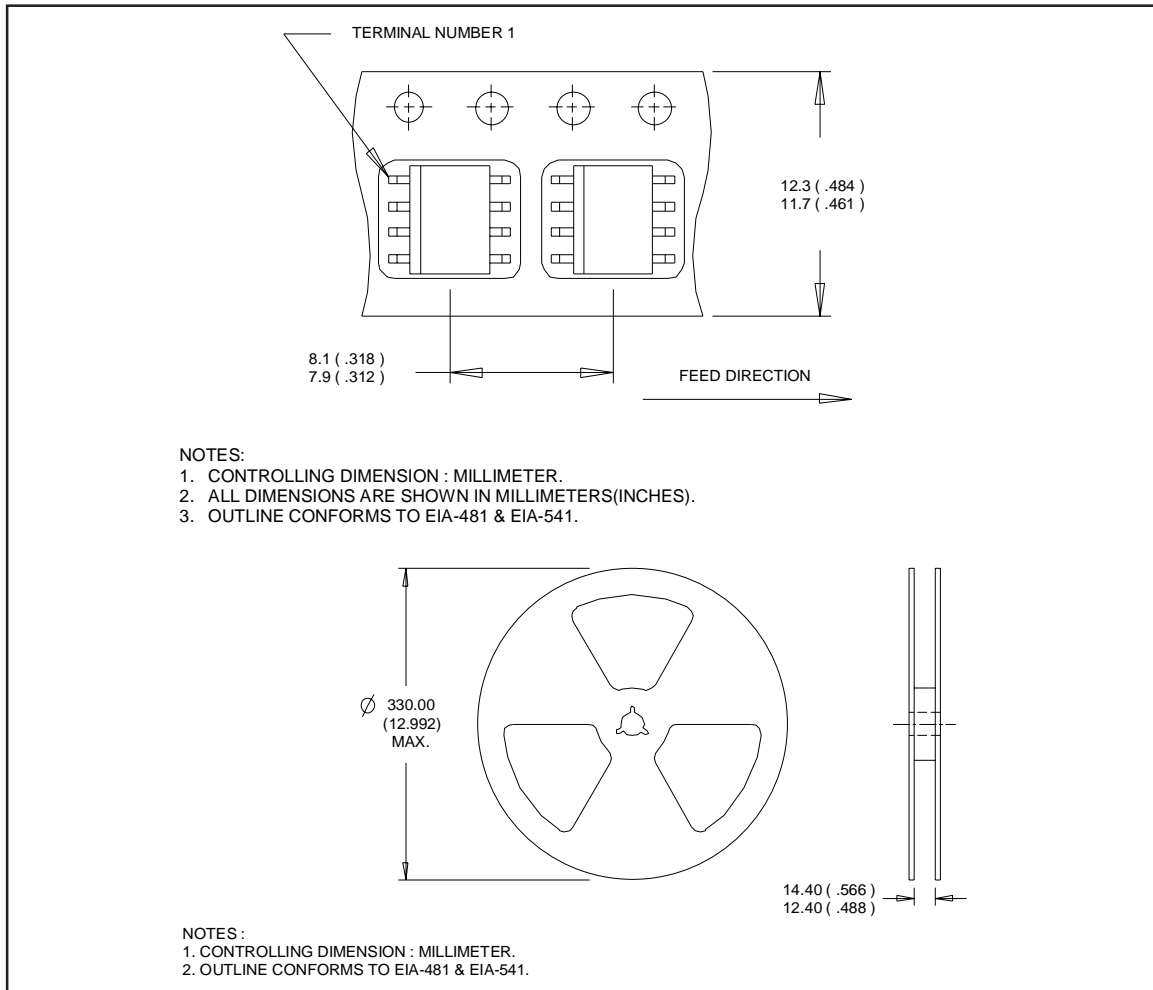

Data and specifications subject to change without notice.

International  
**IR** Rectifier

IR WORLD HEADQUARTERS: 233 Kansas St., El Segundo, California 90245, USA Tel: (310) 252-7105  
TAC Fax: (310) 252-7903

Visit us at [www.irf.com](http://www.irf.com) for sales contact information. 02/04

[www.irf.com](http://www.irf.com)